

29352

Dimensions

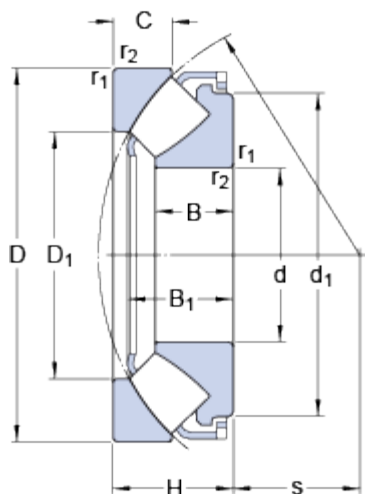

d	260	mm
D	420	mm
H	95	mm
d ₁	≈ 382	mm
D ₁	≈ 324	mm
B	61	mm
B ₁	86.6	mm
C	46	mm
s	148	mm
r _{1,2}	min. 5	mm

Abutment dimensions

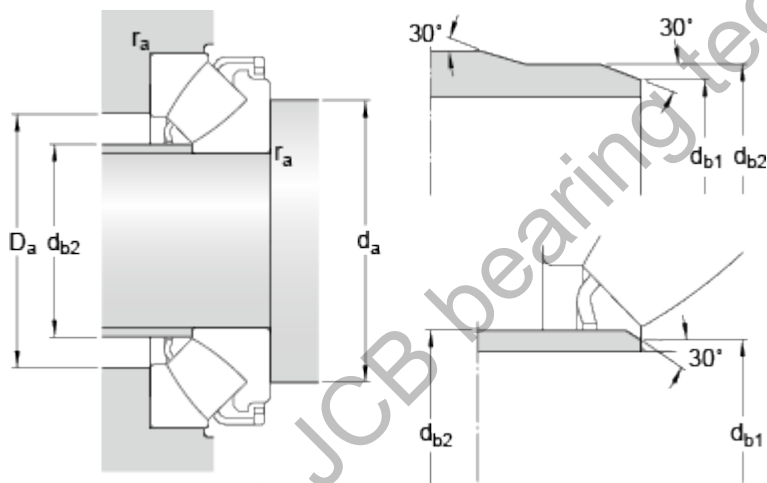

d _a	min. 335	mm
d _{b1}	max. 273	mm
d _{b2}	max. 286	mm
D _a	max. 370	mm
r _a	max. 4	mm

Calculation data

Basic dynamic load rating	C	2550	kN
Basic static load rating	C ₀	8300	kN
Fatigue load limit	P _u	780	kN
Reference speed		850	r/min
Limiting speed		1400	r/min
Minimum axial load factor	A	6.5	

Mass

Mass bearing		49	kg
--------------	--	----	----